

XPEED LX I

Instruction Manual

High Definition Personal
Video Recorder Digital
Satellite Receiver

The XPEED LX1 digital receiver is fully compliant with the international Digital Video Broad-casting (DVB) standard, and thus is able to receive digital broadcasts of that standard.



DVB
Digital Video
Broadcasting

Contents

1	Introduction	5
1.1	Main Features	5
1.2	Product Descriptions	6
1.3	Remote Controller	8
1.4	Conditional Access	9
1.5	Technical Specifications	10
2	Installation of XPEED LX1	12
2.1	Connecting Satellite Cable	12
2.2	Connecting the TV	13
2.3	Connecting Power	14
2.4	Power On/Off	15
3	First Time Installation	16

Safety Precautions

This product has been manufactured to act in accordance with the international safety standards. Please read through the safety instructions carefully before using this product as the manufacturer takes no responsibility for any damages due to the consumer's misuse of the product.

1. Power Supply

- Use this product with the type of power supply that is indicated on the marking label. Its operating range is AC 90V~250V and 50/60Hz.
- Use an outlet that has surge suppression or ground fault protection.
- Do not overload a wall outlet, extension cord or adapter as this may result in electric fire or shock.
- Do not alter, bend, or twist the power cord or plug.
- Be sure to route the power supply cords so that they won't be walked on or pinched by items around it.
- Keep the power cord away from any heating appliances to avoid melting the cover vinyl.
- If the cord is damaged, do not plug in the product and be sure to get the cord replaced.
- When unplugging, grip the power plug, not the cord.
- If any of the following occur, unplug the product from the outlet and contact authorized service personnel:
 - The power cord or supply is damaged
 - Liquids of any kind have been exposed to the product
 - The product has been dropped or the casing has been damaged
 - The product is not performing as it should
- If the product won't be used for a long period of time, unplug it

2. Exposure and Placement

- Only operate the product in moderate temperatures.
- Place the product indoors to avoid exposing it to lightning, rain or direct sunlight.
- Do not expose any liquids or sources of open flame (such as candle flame) to the product.
- Do not place the product near any heat emitting appliances. This may cause impairment in cooling.
- Do not place the product on any unstable surface because it may fall and cause serious personal injuries and/or damage the product.
- Always make sure the product has enough space around it for ample ventilation and heat transfer.
- Do not place the product in a closed space (such as a cabinet) without suitable ventilation.
- Be sure to place the product approximately 10 cm away from any appliances that are exposed to electromagnetic influences, such as a TV.
- Do not use any attachments or accessories that are not recommended by the manufacturer. This may cause hazards to the product, and will **void the warranty**.

3. Installation and Maintenance

- Before connecting or disconnecting the satellite cable to the product, be sure that the product is unplugged. Failure to do so may cause damage to the LNB.
- The LNB cable must be earthed to the system earth for the satellite dish.
- Before connecting or disconnecting the cable from the TV, be sure that the product is unplugged. Failure to do so may cause damage to the TV.
- Before cleaning the product, be sure that the product is unplugged.
- Use a damp cloth (do not use any solvents) to clean the exterior of the product.

4. Warnings

- Do not use this product near any flammable or explosive gases as this increases the risk of explosions.
- Do not use the product if any liquids or foreign objects come in contact with it.
 - Turn the product off, disconnect the power cord, and contact your dealer.
 - Do not use the product since this could cause a fire or electric shock.
- Do not operate this product or hold the power cord with wet hands as the risk of getting electronic shock is very high.
- Unplug the product and disconnect the LNB cable during a thunderstorm or when left unattended and unused for long periods of time. This will prevent damage to the product due to lightening and power-surges.
- Do not use this product when it is out of order. Continued use when defective can cause serious damage to it and you.
- Do not put any alien items into or block the slots or ventilation openings of the product. This can cause damage to the product and reduce the life span.

5. Warranty

Be aware that any adjustments or handling (such as, but not limited to opening the casing) other than what is specified here will **void your warranty**. Attempting to modify the product may result in fire, injury, electric shock, or other severe damage to you or the product.

- Do not remove the cover, as there is risk of electric shock.
 - If it is absolutely necessary, please contact a trained professional.
- Do not try to modify the product as this may cause fires, injuries, electronic shocks or other severe damage to you or the product.

Chapter1.

Introduction

The XPEED LX1 digital receiver is fully compliant with the international Digital Video Broadcasting (DVB) standard, and thus is able to receive digital broadcasts of that standard. For its operation you need an antenna, which must be installed appropriately.

1.1 Main Features

- 3300 MIPS Processor
- Linux Operating System
- Media Player
- Downloadable Plug-in supported
- 2 x Smartcard Readers
- MPEG2 / H.264 Hardware Decoding
- 1 x DVB-S2 Tuner
- 7-Segment display
- 512MB NAND Flash
- 512MB DDR SDRAM
- 10/100MB Ethernet Interface
- 2 x USB 2.0
- RS-232
- HDMI
- 1 x SCART
- S/PDIF for digital bit stream out
- EPG supported
- Automatic & Manual Service Scan supported
- Multiple LNB control (DiSEqC) supported
- Skin change supported

1.2 Product Descriptions

Front Panel

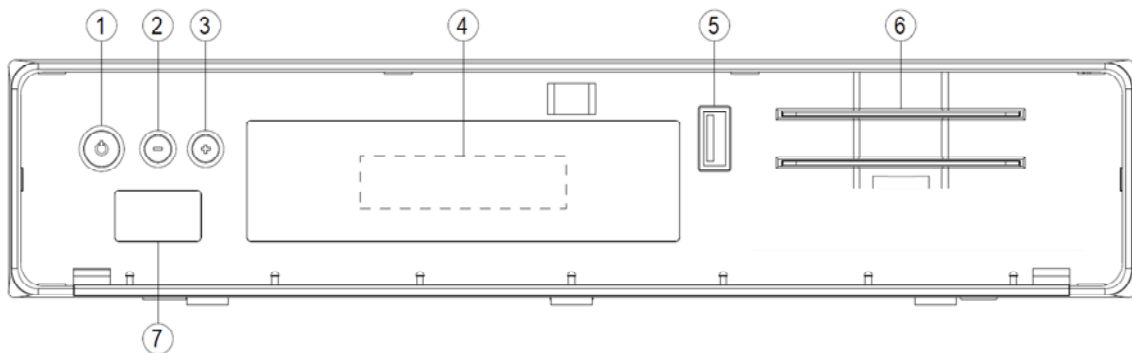

- ① **Power** : Power On
- ② **VOL▼** : Volume control
- ③ **VOL▲** : Volume control
- ④ **Display** : Displays the current menu information
- ⑤ **USB**: Connect a USB storage device
- ⑥ **Smartcard reader slot 1 & 2**
- ⑦ **IR / LED**: IR Receiver and Indicator LED

Rear Panel

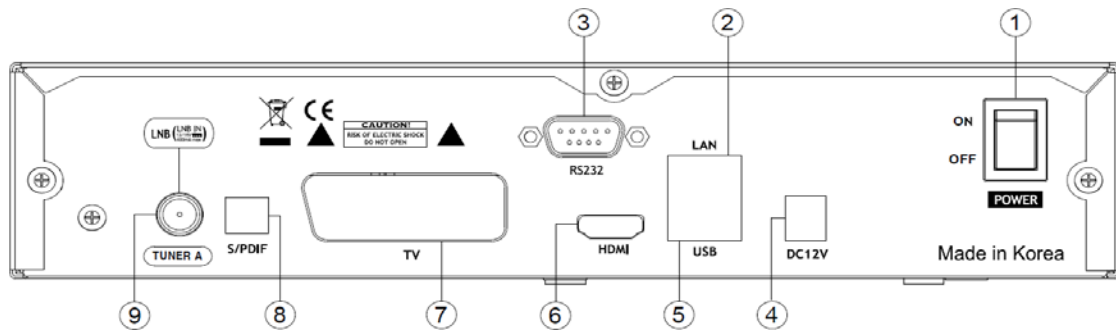

- ① **On/Off Switch** : Powers on/off
- ② **Ethernet** : Connects the PC or another set top box of ET
- ③ **RS-232** : RS-232 data port is provided
- ④ **DC IN plug** : 12Vdc
- ⑤ **USB** : Connects the USB memory stick or external HDD
- ⑥ **HDMI** : Connects to TV using a HDMI cable for both audio and video signals
- ⑦ **TV SCART** : A SCART connector is provided for TV using a SCART cable
- ⑧ **S/PDIF** : Connects to a digital audio system using S/PDIF cable
- ⑨ **TUNER A** : A satellite cable can be connected

1.3 Remote Controller

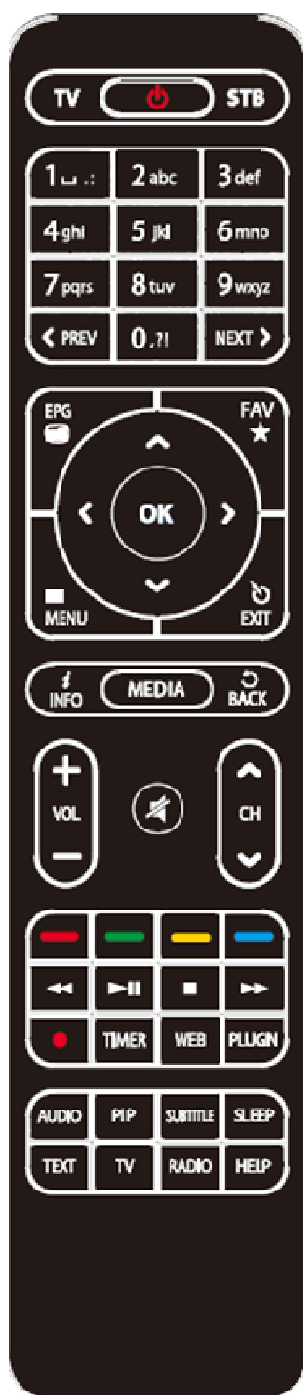

- **TV/STB** : Puts the Remote in TV or STB mode.
- **⏻** : Press to go into Standby / Standby options.
- **0 - 9** : Used for entering channel number and text.
- **PREV** : Go to Previous Channel in History.
- **NEXT** : Go to Next Channel in History.
- **EPG** : Shows the EPG for all / current channel.
- **FAV** : Show the Favorite Lists available.
- **MENU** : Go to Main Menu / Menu for current function.
- **EXIT** : Exit current Menu or Window.
- **OK** : Confirms the option.
- **INFO** : Shows more information.
- **MEDIA** : Show recordings. Long press goes to Media player
- **BACK** : Shows Channel History.
- **VOL+/-** : Increase or Lower the Volume.
- **CH+/-** : Change channel to Next / Previous.
- **🔇** : Mute the sound.
- **COLOR** : Color buttons for different operations.
- **⏮/⏭** : Fast Forward / Rewind. (x2/4/8/16/32/64/128)
- **▶/⏸/■** : Play / Pause / Stop Timeshift or Media playback
- **●** : Start a recording / Show recording options.
- **TIMER** : Go to Timers / Timer overview.
- **WEB** : Go to Web browser.
- **PLUGIN** : Go to Plugins menu.
- **AUDIO** : Show available Audio tracks.
- **PIP** : Picture in Picture.
- **SUBTITLE** : Shows subtitles if supported.
- **SLEEP** : Go to Power Timers.
- **TEXT** : Shows Teletext if supported.
- **TV** : Go to TV mode.
- **RADIO** : Go to Radio mode.
- **HELP** : Shows HELP menu in TV mode.

1.4 Conditional Access

Amongst the channels that are scanned via XPEED LX1, some channels can be properly tuned in only with the corresponding Smartcard. XPEED LX1 provides two Smartcard Reader slots and users need to purchase those Smartcards that are required for viewing such subscription based services.

Insertion of Smartcard

- ① Open the door on the right side.
- ② Insert Smartcard as in the following instruction.
- ③ Make sure that the Smartcard remain inserted while viewing.

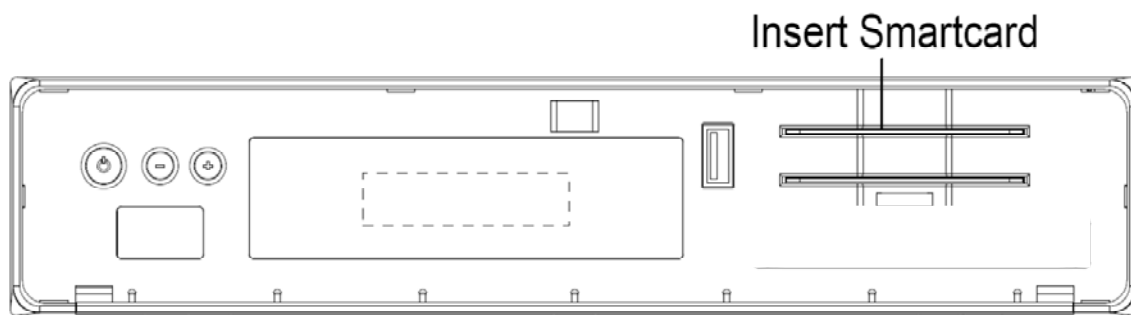

1.5 Technical Specifications

Front Panel

- Display: 7-Segment display
- Smartcard Reader Slot: 2 ea
- USB: 1 x USB 2.0
- Buttons: 3 (Power, Volume Up/Down)

Rear Panel

- Power Switch: 1 ea
- Sat-IF input: 1 x F-type socket
- Connection TV: SCART
- Video/Audio output (digital): 1 x HDMI
- Audio output (digital): Standard optical (S/PDIF)
- USB: 1 x USB2.0
- Ethernet: 1 ea
- RS-232: 1 ea

Power

- Mains voltage: 95~250 / 50~60 V/Hz
- Max Power consumption: 40 / 0.5 W
(Max./Deep stand-by)

RF

- RF range: 950~2,150 MHz
- Modulation, FEC, de-multiplexer: DVB-S/DVB-S2 standard

11 Introduction

Video

- Video resolution: CCIR601 (720 x 576 lines), 576p, 720p, 1080i, 1080p@30
- Video decoding: MPEG-2, MPEG-4 compatible
- Input data rate: 2~45 MSymb/s
- S/N: > 53 dB

Audio

- Decoding: MPEG-4(AAC-HE), MPEG-1 Layer1, 2 and 3
- Sampling rate: 32 / 4.1 / 48 KHz
- S/N: > 65 dB

LNB

- LNB supply (hor/ver): 14 / 18 ; Max. 400mA
- Control signal: 22 KHz ; Tone Burst ; DiSEqC™1.0 / 1.1 / 1.2

General

- Dimensions (W x H x D): 260 x 55 x 180 mm
- Weight (without HDD): App. 1 KG

Chapter2.

Installation of XPEED LX1

This chapter will guide you through the whole installation process of XPEED LX1. Please read each section carefully to make sure that the system runs properly.

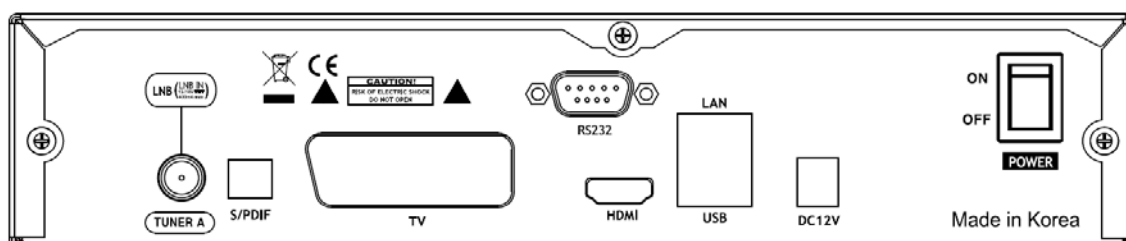

2.1 Connecting Satellite Cables

XPEED LX1 is integrated with triple satellite tuners, and one of the first steps is to connect satellite cable(s) to XPEED LX1 in order to gain optimal signal quality. You can either choose one of the following connection methods depending on the equipment you have.

A. Satellite Cables

In case you have only one satellite cable, connect the cable to TUNER A Input.

Or you can connect signal from LNB out line of other STB for Loop through output.

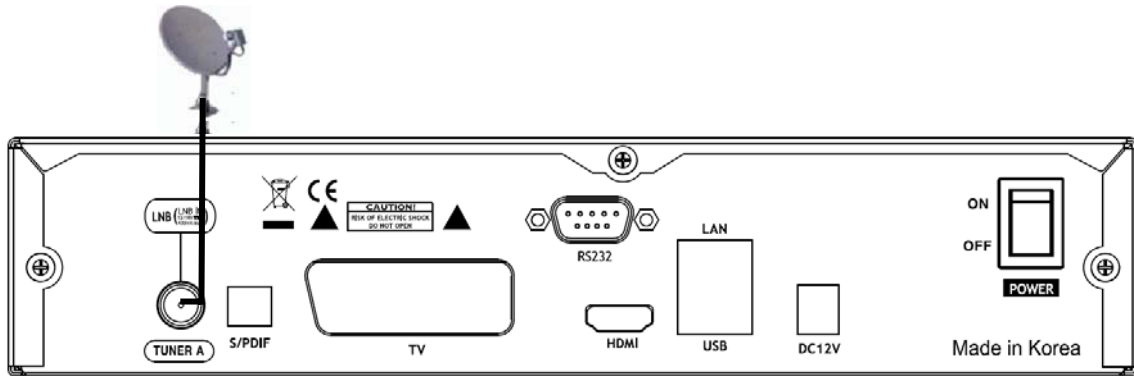

2.2 Connecting the TV

XPEED LX1 provides a variety of audio/video connection methods.

A. Connecting TV via HDMI Cable

For the sake of the best picture quality, especially for digital TV, HDMI connection is recommended. Most HDTVs have HDMI connectors to ensure the highest picture quality.

In the rear panel of XPEED LX1 one HDMI connector is available for this purpose.

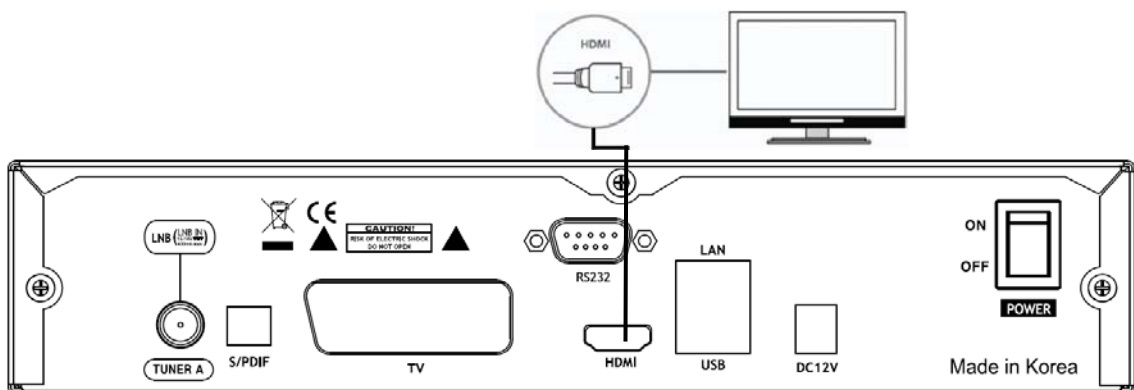

B. Connecting TV SCART Cable

In case your TV is analogue TV, SCART cable is the most common method. Connect your TV to XPEED LX1 using SCART cable as follows

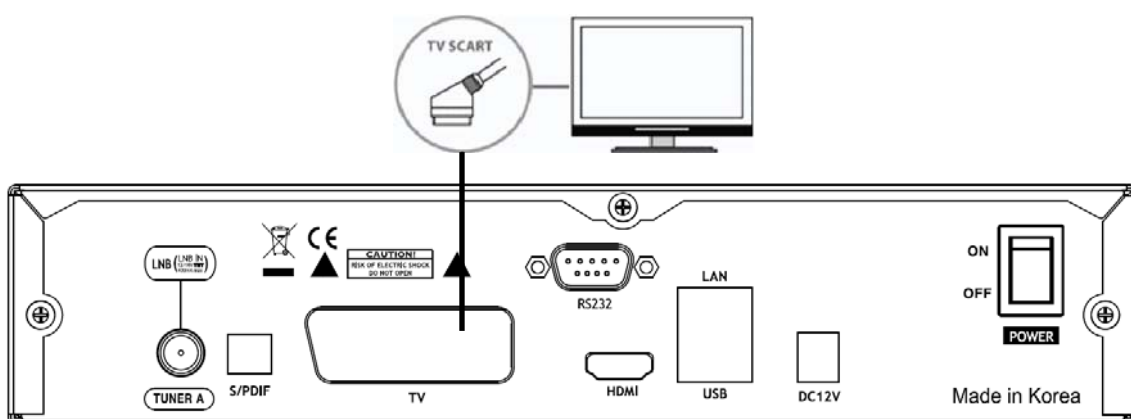

NOTE: When you have an A/V receiver with S/PDIF digital audio input, this connection is recommended to enjoy the best audio quality, especially for the Dolby Digital sound.

2.3 Connecting Power

A power unit is provided as one of the basic accessories of XPEED LX1.

- Connect the power unit to the connector at the rear panel of XPEED LX1.
Turn on the power switch at the rear panel.

2.4 Power ON/OFF

[Press  → 'Standby/Restart']

There are several ways to turn your XPEED LX1 ON or OFF

- **Complete Power Shutdown**

There is a Power Switch in the rear panel and once it is ON, you do not need to turn it on or off each time. It takes a longer time to boot the system if you turned it off by this switch.

- **Standby Mode**

POWER key is normally used to turn the power of XPEED LX1 on or off. If you press POWER, it instantly switches your XPEED LX1 off or on. In this mode, the system is not completely shut down and thus it takes a shorter time to turn it on and off.

- **Deep Standby Mode**

Deep Standby is used to reduce the standby power consumption. XPEED LX1 is designed to be energy efficient and to guarantee the power consumption to be under 1W in the deep standby mode.

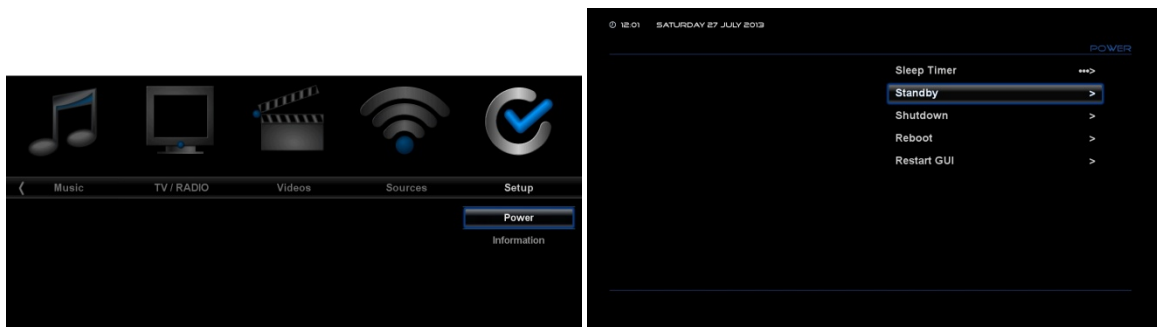

Chapter3. First Time Installation

When you turn on XPEED LX1 for the first time after purchase, an installation wizard will begin step by step.

NOTE: 'OK' key is used for confirmation and turns to the next step. Press 'EXIT' key to return to the previous page.

Step 1. Video Input Selection

XPEED LX1 will automatically probe the video input port. Press OK if you can see this page on your TV. Or you can select a different input port (HDMI, SCART, or YPbPr). Use UP/DOWN key to scroll up and down to find the input port you want.

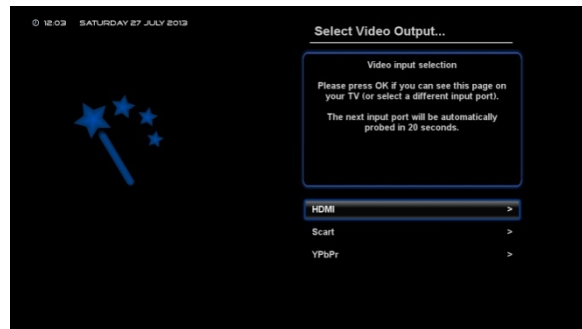

Step 2. Video Mode Selection

XPEED LX1 provides various video modes. You can choose one. Use UP/DOWN key to scroll up and down to find the mode you want.

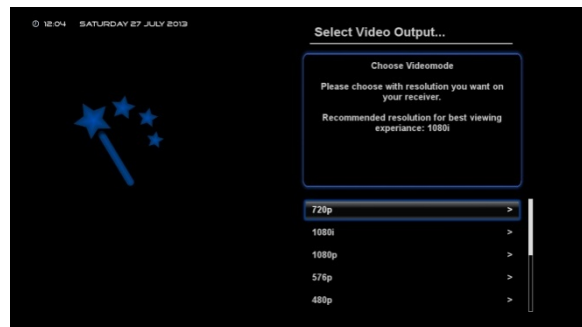

Step 3. User interface and DHCP

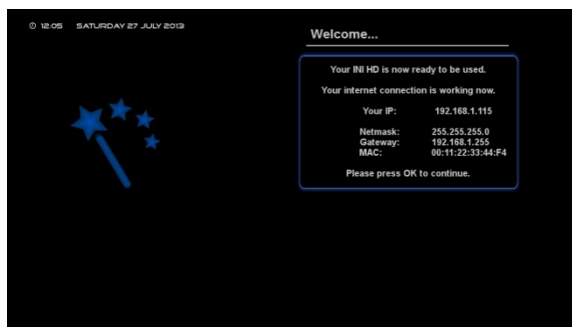

Step 4. User interface(Language Selection)

XPEED LX1 provides various languages and here you can choose the main language for your XPEED LX1. Use UP/DOWN key to scroll up and down to find the language you want.



Step 5. Setup basic feature or Exit

From now on you need to configure the satellite connection. You have two options:

- Use wizard to setup basic features
- Exit wizard

You are strongly recommended to use wizard as it is designed to guide you through the configuration process.

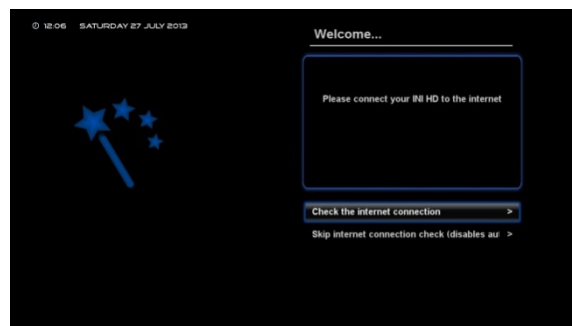
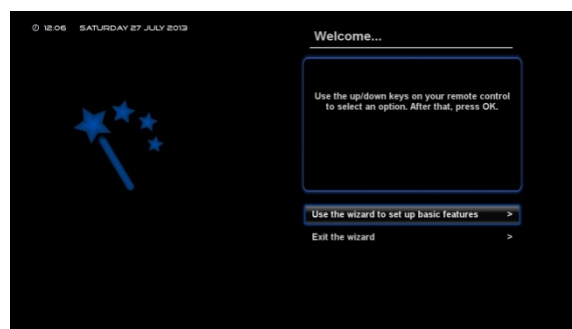

Step 6. Configuration mode

Using LEFT/RIGHT key, you can choose one of the following Configuration Modes:

- Simple
- Not configured.
- Loop-through to: mode to make the TUNER 1 be internally connected to the TUNER 2.
- Equal to: mode to use the same configuration as that of Tuner B.
- Advanced: for an advanced user configuration.

① Not configured



② loopthrough to



③ equal to

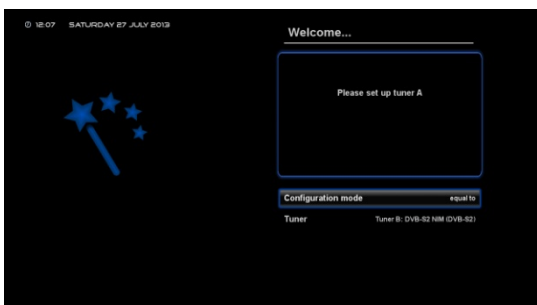

④ Advanced

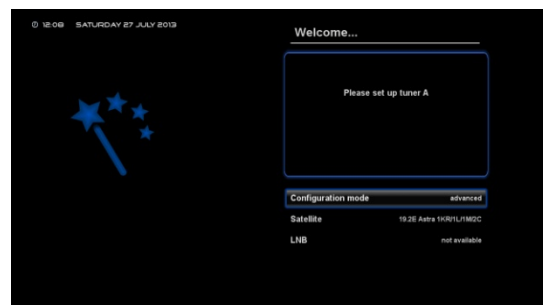

Step 7. Configuring Tuner A

Using LEFT/RIGHT key, you can choose one of the following Configuration Modes:

- Not configured.
- Simple
- Loop-through to: mode to make the TUNER 1 be internally connected to the TUNER 2.
(Model LX1 has one input tuner. It can't be loop through function)
- Equal to: mode to use the same configuration as that of Tuner B.
(Model LX1 has one input tuner. It can't be loop through function)
- Advanced : for an advanced user configuration.

If you choose Simple configuration mode, the following picture will appear.

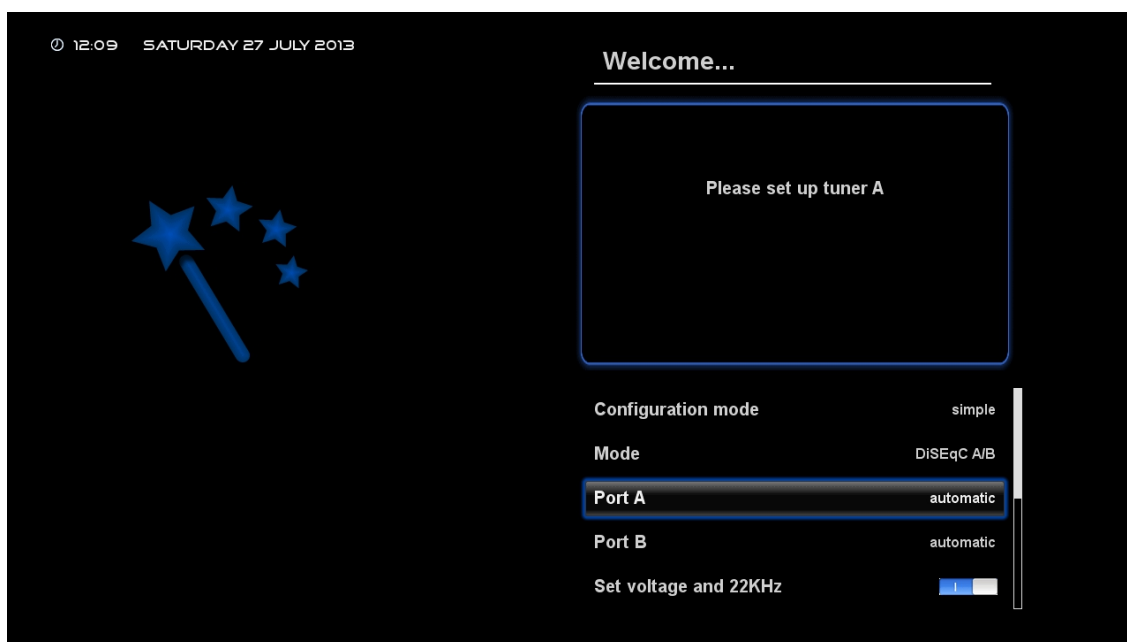

The five modes are available for the satellite cable connection between LNB and your XPEED LX1 as below:

Single

This option is used to receive a single satellite with a single LNB. The cable from LNB is directly connected to **XPEED LX1**.

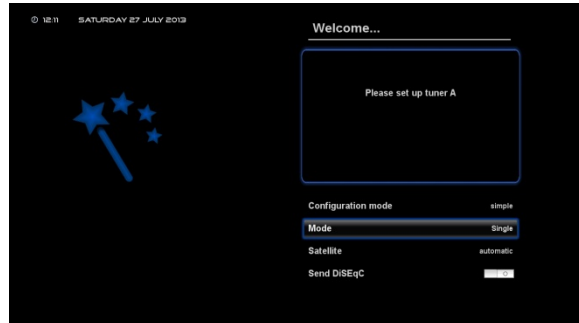

ToneBurst A/B

This option is used if you want to receive two satellites using a ToneBurst switch.



DiSEqC A/B

This option allows you to configure two satellites in Port A and Port B.



DiSEqC A/B/C/D

This option allows you to configure four satellites in Port A, Port B, Port C, and Port D.



Positioner

This option is used when you have a motorized satellite antenna.



Step 8. Configuring Tuner B

This step is for the configuration of TUNER B Input and the process is same as that of Tuner A. For further information please refer to the above “Step 7. Configuring Tuner A” section. XPEED LX1 support to one input tuner only.