

XCRUISER

User's Manual



XDSR385HDplus

Full HD
Digital Satellite Receiver

v1310

Please read this User's Manual carefully before installing the receiver.

CONTENTS

1 Introduction	4	4 Watching TV	13
1.1 Features	4	4.1 Channel List	14
1.2 Accessories	4	Channel List Preferences	14
1.3 The Remote Control	5	4.2 TV Programme Guide	15
1.4 Getting Started	6	Programme Guide Preferences	15
1.5 The Apps Screen	6	4.3 Controlling Audio	16
2 Installation	7	4.4 Displaying Subtitles	16
2.1 Satellite Dish Connection	7	4.5 Watching Two Channels Simultaneously	16
2.2 TV Connections	7	4.6 Viewing Teletext	16
HDMI connection	8	4.7 Watching Pay Channels	17
Composite Connection	8	4.8 Watching Subchannels	17
2.3 AV Receiver Connection	8	4.9 Setting Up Timers	17
2.4 Network Connection	8	Wake-Up Timer	17
2.5 Mounting Receiver Connection	9	Sleep Timer	17
		4.10 Managing Channels	17
		4.11 HbbTV	19
3 Scanning for Channels	10	5 Recording TV	19
3.1 Satellite Dish Settings	10	5.1 Recording TV Programmes	19
LNB Settings	10	Scheduling TV Recordings Using...	19
Unicable Settings	10	Manually Scheduling TV Recordings	19
3.2 Using a Motorized Dish	11	5.2 Time-Shifting	20
Using DiSEqC 1.2	11	5.3 Playing Recordings	20
Using USALS	12	5.4 Recording Preferences	20
3.3 Scanning for Satellite TV Channels	12		
Scanning for Every Channel	12		
Scanning a Specific Transponder	13		
Scanning for One Channel	13		

6	Playing Media Files	21
6.1	Managing Storage Devices	21
6.2	Managing Files	21
6.3	Playing Recordings and Videos	22
6.4	Viewing Photos	23
	Slideshow Preferences	23
6.5	Playing Music	23
6.6	Playing Media Files from other Devices	23
7	Apps	24
7.1	Web Browser	24
	Viewing a Webpage	24
	Navigating Webpages	24
	Bookmarks	24
	Entering Text	25
7.2	YouTube	25
	Playing Videos	25
7.3	Free TV+	25
7.4	Internet TV+	25
7.5	Internet Radio+	26
7.6	RSS News	26
7.7	User Data	26
7.8	TV Portal+	27
7.9	Torrent Player	27
7.10	Weather Forecast	27
7.11	PlugIn	28
	PlugIn Server Settings	28

8	Preference Settings	28
8.1	Language Settings	28
8.2	Network Settings	28
	Proxy Server Settings	28
	DDNS Settings	29
8.3	Clock Settings	29
8.4	Audio and Video Settings	29
8.5	On-Screen Display Settings	30
	Using Different Fonts	30
8.6	Parental Control	30
8.7	Maintaining the Digital TV Receiver	30
	Sharing Channel Data	31
8.8	Updating the Digital TV Receiver	31
	Online Update	31
	Software Server Settings	31

9	Appendix	32
	Legal Notices	32
	Correct disposal of this product	32

1 INTRODUCTION

1.1 Features

Beyond simply receiving satellite signals, this digital TV receiver has many convenient and advanced features:

- This receiver has two slots for CA modules and pay-TV cards. See *Watching Pay Channels*.
- Users can use removable storage devices to record TV programmes. It is possible to schedule this receiver to record not only a single TV programme but also every episode of a series using the programme guide. See *Recording TV*.
- Users can pause and resume a live programme. See *Time-Shifting*.
- This receiver can play many kinds of media files, including photos, music, and videos. See *Playing Media Files*.
- This receiver can play media files from other devices, such as computers and network-attached storages. See *Playing Media files from Other Devices*.
- This receiver provides a variety of apps, including YouTube. See *The Apps Screen*.

1.2 Accessories

The following accessories are included with the digital TV receiver.

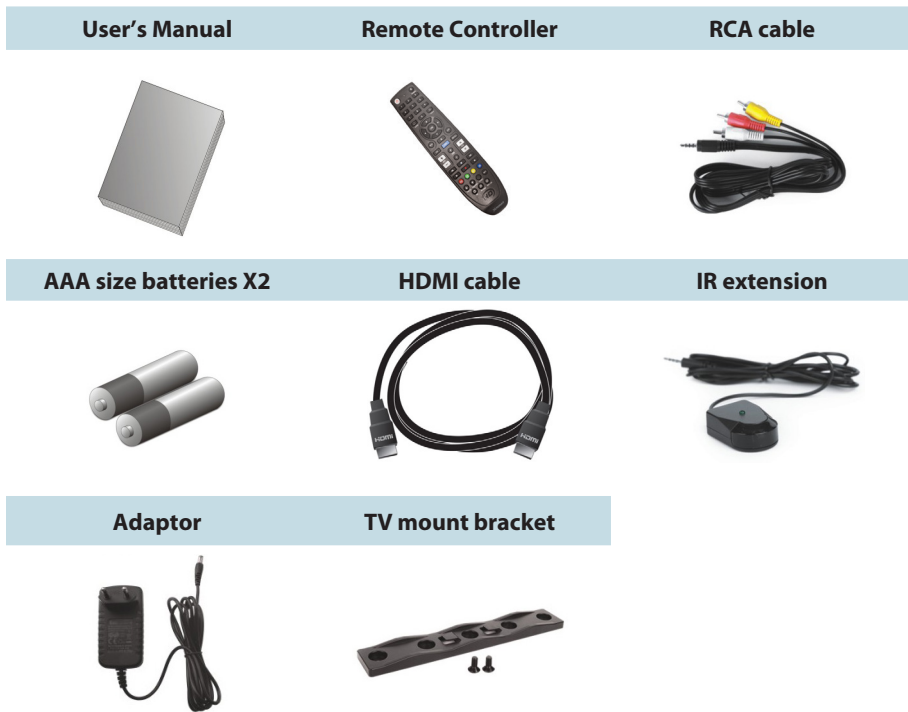

1.3 The Remote Control

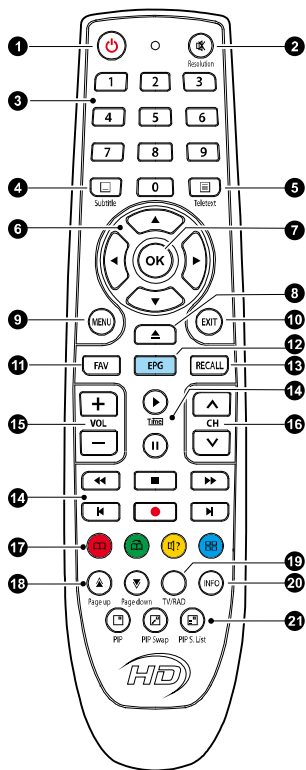

Use the remote control to control the digital TV receiver. Make sure that batteries are installed correctly in the remote control.

1. Turn the digital TV receiver on or off.

2. Mute the sound.

This button also can be used to change the picture resolution. Press and hold this button until the current resolution is displayed. Repeatedly press it to change the resolution, then press the **EXIT** button to return it to the original button function.

3. Use the numeric buttons to enter numbers.

4. **Subtitle**: Display subtitles. See **Displaying Subtitles**.

5. **Teletext**: Display teletext pages. See **Viewing Teletext**.

6. Use these navigation buttons to navigate the menus and interactive screens.

7. **OK**: Select an item. In addition, use this button to display the channel list. See **Channel List**.

8. Display the list of files stored in a removable storage device. See **Playing Media Files**.

9. **MENU**: Display Apps. See **The Apps Screen**. In addition, use this button to return to the higher menu level.

10. **EXIT**: Return to the previous screen or close the current list or dialogue box.

11. **FAV**: Display the list of favourite channels.

12. **EPG**: Display the programme

guide. See TV Programme Guide.

13. **RECALL**: Display the list of recently-viewed channels.

14. Use these buttons to control recording and playback. See Recording TV and Playing Media Files.

15. Use these volume buttons to adjust the volume.

16. Use these channel buttons to change channels.

17. These color buttons perform different functions, depending on what the digital TV receiver is currently doing.

18. Use these buttons to scroll lists.

19. **TV/Radio:** Switch between TV channels and radio stations.
20. **INFO:** Display information about the current programme.
21. Use these buttons to watch two different channels at the same time. See *Watching Two Channels Simultaneously*.

1.4 Getting Started

Install the digital TV receiver properly, referring to Installation.

Plug the power adapter into a power outlet, and insert the connector into the power socket on the rear of the receiver. Then press the power button  on the remote control to turn on the receiver.

When turning on the receiver for the first time, the initial setup process automatically starts. Follow on-screen instructions to finish the process. At each step, either make a choice or skip the step:

1. Choose a language for the user interface.

2. Configure the network settings. See *Network Connection*.
3. Install add-ons to internet-based apps, such as Free TV+ and Internet Radio+, when an internet connection is available. Additionally, determine whether to restore the receiver using the stored settings and channels, if there is any backup data.
4. Set the clock. See *Clock Settings*.
5. Scan for TV channels. See *Scanning for Channels*.

1.5 The Apps Screen

Press **MENU** button to open Apps screen. The Apps screen displays various app icons in multiple folders, as follows:

- **CAS:** See *Watching Pay Channels*.
- **Data Transfer:** See *Sharing Channel Data*.
- **Media Server:** See *Allowing Other Devices to Access the Receiver*.
- **Remote Play+:** See *Playing Media files from Other Devices*.
- **Schedule:** See *Manually Scheduling TV Recordings*.



- **Software:** See *Online Update*.
- **Storage Manager:** See *Managing Storage Devices*.
- **System:** See *Updating Digital TV Receiver*.
- **USB Storage:** See *Updating Digital TV Receiver*.

For other apps, see *Apps*.

Note

While some apps, such as Calendar, are easy to use, other internet-based Apps may be unavailable or restricted, depending on the country, so this guide does not cover every app provided by this receiver.

To access the customary setting menus, select Settings or, alternatively, press the red button to quickly access it.

2 INSTALLATION

Install the digital TV receiver, limited by the specifications shown in the table below.

Max. power consumption	28 W when in operation
Size	220 x 35 x 145 mm
Weight	0.6 kg
Operating temperature	32-113 °F, 0-45 °C
Storage temperature	14-158 °F, -10-70 °C

On the rear, this digital TV receiver has several connectors:

- A satellite dish connector
- AV connectors for a TV and an AV receiver
- USB ports for removable storage devices
- An Ethernet port for internet connection
- A remote control extender connector

2.1 Satellite Dish Connection

Connect the cable from the satellite dish to LNB IN.

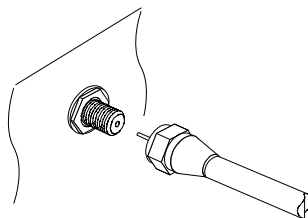

2.2 TV Connections

This digital TV receiver has two video connectors for use by a TV.

- HDMI
- Composite video

Use an HDMI connector to connect the receiver to a TV for the best picture quality. If the TV has no available HDMI connector, use the composite video connector.

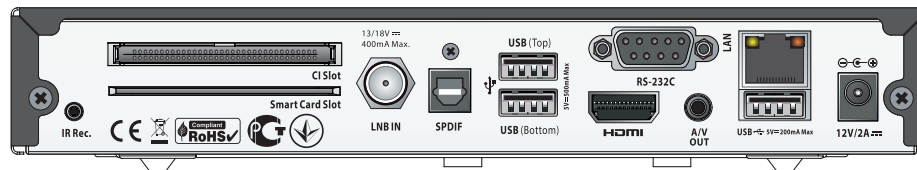

The **RS-232C** port may be used only by an engineer for installation or service.

HDMI connection

Connect the receiver's HDMI output connectors to the TV's HDMI input connector using an HDMI cable.

Note

Some HDMI cables and TVs may not be compatible with the receiver due to differing HDMI specifications.

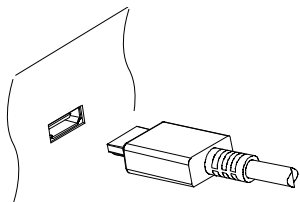

Composite Video Connection

The composite video connector shares the audio connectors with the component video connectors. A typical composite cable has three connectors.

The yellow connector is for the video connection. Connect the receiver's composite video and audio output connectors to the TV's composite video and audio input connectors using a composite cable, so that the connectors of the same color connect to each other.

Note

Composite video connectors cannot carry HD video.

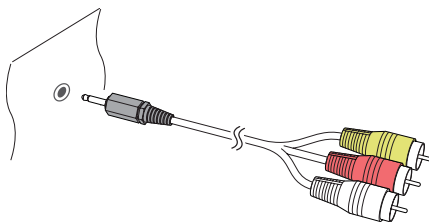

2.3 AV Receiver Connection

Use an AV receiver for better audio quality. Connect the receiver's SPDIF connector to the AV receiver's digital audio input connector using an optical audio cable.

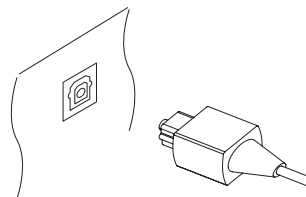

2.4 Network Connection

Connect the receiver's LAN port to the router using a network cable. For details on how to configure the network settings, see Network Settings on page 50.

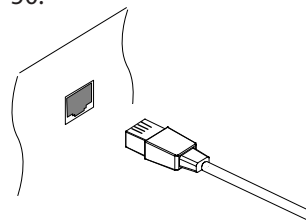

2.5 Mounting Receiver on a TV

If necessary, mount the receiver on the TV to save space. Install the TV mount bracket on the back of the TV, and then attach the receiver to the bracket, as opposite illustration shows.

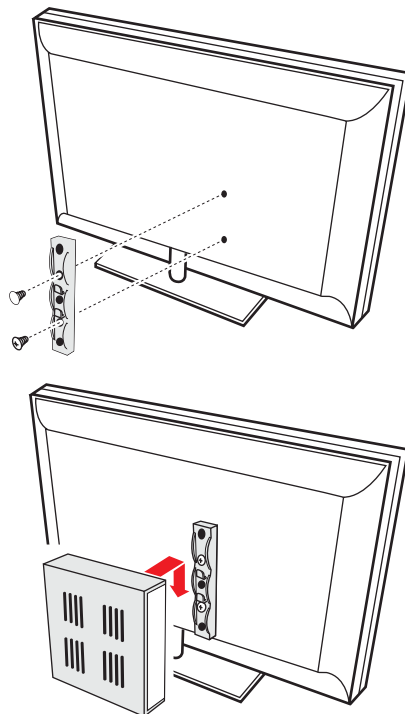

Connect the remote control extender to the IR Rec. socket on the receiver. Make sure that the extender does not face directly into light sources, such as lamps or displays. Directing light at the extender may interfere with remote control signal transmission.

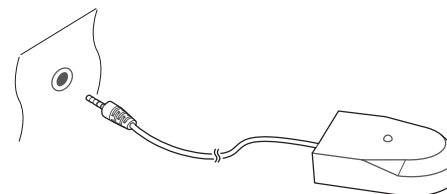

Connect the receiver's LAN port to the router using a network cable. For details on how to configure the network settings, see *Network Settings*.

3 SCANNING FOR CHANNELS

3.1 Satellite Dish Settings

LNB Settings

A group of satellite dish settings must be properly configured for each desired satellite before performing a channel scan.

Open the Apps screen and select **Settings > Dish Setting**. There are two signal bars on the lower part of the screen. The signal level bar indicates how strong signal is, and the signal quality bar indicates how easy it is to pick up. To view an enlarged signal bar display, press blue button.

Configure the following settings properly using the signal bars.

Satellite: Choose a target satellite from the list of satellites.

Frequency: Choose a target transponder from the list of transponders.

LNB Power: An LNB must be supplied with power to operate. Turn this on to supply the LNB with power if it doesn't have its own power supply.

LNB Type: Specify what type of LNB is used.

LNB Frequency: Specify what frequency the LNB generates. A dual-band LNB, also called universal LNB, generates two alternative frequencies to receive a wider band of satellite frequencies.

LNB 22 kHz: Either turn this on or off to pick up a higher or lower frequency band.

DiSEqC Switch: If one or more typical DiSEqC switches are used, this option must be set properly. Specify which of the DiSEqC ports is connected to the intended dish.

On this screen, users can change satellite and transponder data.

Rename a satellite: Choose **Satellite** and select a satellite. Press the red button and then enter a new name using the on-screen keyboard.

Edit a satellite's longitude: Choose **Satellite** and select a satellite. Press the green button and then modify the longitude.

Clear all transponders of a satellite: Choose **Satellite** to select a satellite. Press yellow button and then confirm to clear them.

Add a transponder: Place the focus on Frequency and press the green button. Specify the frequency, symbol rate, and polarization.

Edit a transponder: Choose **Frequency** and select a transponder. Press the yellow button and then modify the transponder's details.

Delete a transponder: Choose **Frequency** and select a transponder. Press the red button and then confirm to delete it.

Unicable Settings

If the user's house is equipped with a single cable router, configure unicable settings properly.

Open the Apps screen and select **Settings > Dish Setting**. Set LNB Type to Unicable and then choose Unicable Setting. Choose Config Mode and determine whether to scan for all available channels or a specific channel.

Specify the details, such as port and predetermined intermediate frequency.

3.2 Using a Motorized Dish

While a fixed dish usually only picks up one satellite, a motorized dish can pick up multiple satellites.

There are two control methods for motorized dishes: DiSEqC 1.2 and USALS. With DiSEqC 1.2, the user must manually operate the dish to locate satellites one by one. The digital TV receiver stores each satellite position for later use.

With USALS, the receiver can pinpoint all visible satellites through calculations using the dish coordinates and the built-in database of satellite positions.

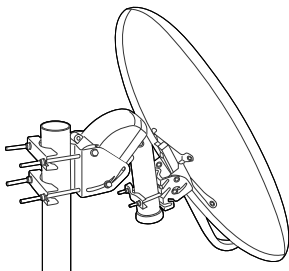

Using DiSEqC 1.2

Open the Apps screen and select **Settings > Positioner Setting**. Set **Positioner to DiSEqC 1.2** and then repeat these steps for every desired satellite.

1. Choose **Go to Reference** from **Positioner Command** for the dish to return to the reference point at the highest point in its arc. The dish's movement accuracy may decrease over long-term use. To correct movement errors, choose **(Re-) Calculate** from **Positioner Command**.
2. Choose Satellite and choose a target satellite.
3. Choose Frequency and select any available transponder.
4. Choose **Go to Stored Position** from **Positioner Command** to rotate the dish, so that it faces the target satellite.
5. Place the focus on **Move** and press the left or right navigation button to finely drive the dish east or west for the best signal. The dish rotates continuously as

long as either of these buttons is held down.

6. Choose **Store Satellite Position** from **Positioner Command** to save the dish's current position for the target satellite.

It may be useful to set limits to the movement scope of the dish for easier manipulation. Repeat these steps two times to set a limit position for the east and the west.

1. Choose **Go to Reference** from **Positioner Command** for the dish to return to the reference point.
2. Place the focus on **Move** and press the left or right navigation button to drive the dish.
3. Choose **Set East (soft) Limit** or **Set West (soft) Limit** from **Positioner Command** to save the dish's current position to use it as a limit position.

Choosing **Disable (soft) Limits** from **Positioner Command** clears these limit positions.

Using USALS

Open the Apps screen and select **Settings > Positioner Setting**. Set **Positioner** to **USALS** and then specify these items correctly:

- **Dish Longitude:** Enter the longitude where the dish is located.
- **Dish Latitude:** Enter the latitude where the dish is located.

Give the dish a test run to see if it works properly. Repeat these steps for every desired satellite.

1. Choose **Go to Reference** from **Positioner** Command for the dish to return to the reference point.
2. Choose **Satellite** and choose a target satellite.
3. Choose **Frequency** and select any available transponder.
4. Choose **Go to** to rotate the dish so that it faces the target satellite.

3.3 Scanning for Satellite TV Channels

Open the Apps screen and select

Settings > Service Search.

Three methods are available to scan for satellite TV channels.

- Scanning all available transponders for every channel
- Scanning for multiple channels that a specific transponder carries.
- Scanning for a specific one of multiple channels that a specific transponder carries.

Some option items are used in common in more than one scanning method, as follows:

- **Satellite:** Choose a target satellite from the list of satellites.
- **Search Type:** Determine which types of channels to scan for.
- **All Service:** Scan for all available TV and radio channels.
- **FTA Only:** Scan only for free TV and radio channels.
- **TV Only:** Scan only for free and pay TV channels.
- **Network Search:** A transponder usually has information about other transponders

provided by the same satellite TV service provider. It is better to turn on this option so that the receiver uses broadcast network information for faster and more precise scanning.

When any dish settings need to be reconfigured, select **Dish Setting** or **Positioner Setting** to jump to the relevant menu. To return to this menu, select **Service Search**.

Particular LNBS have an indicator light to show if the signal strength is good enough for the receiver to perform a channel scan. This may be useful when installing a new satellite dish. To activate this function, press the green button and then confirm to use it.

Scanning for Every Channel

Three methods are available for scanning for every channel.

- **Set Search Mode to Auto.** With this method, the receiver uses its numerous database of transponders when scanning for channels. Choose Time Calibration and determine how long the receiver should

wait to get time information from each transponder.

- **Set Search Mode to Blind.** Transponders occasionally change, so the receiver may happen to miss some channels when scanning for channels using the transponder database. With this method, the receiver scans all potential transponders using every possible combination of transponder elements not to miss any channel in a scan. However, it takes much longer time.
- **Set Search Mode to Fast Scan.** Particular satellite TV service providers manage dedicated transponders to provide up-to-date transponder information. With this method, the receiver uses that sort of transponder for faster and more precise scanning. Choose Select Operator and select a satellite TV service provider.

Make sure that the common options are properly configured before selecting Service Search to start a channel scan.

Scanning a Specific Transponder

Generally, one transponder carries multiple TV channels. To scan a specific transponder for the channels it carries, set Search Mode to Manual. Users need to get several details about a target transponder.

- **Frequency:** Choose a target transponder from the list of transponders.
- **Symbol rate:** Specify the transponder's symbol rate.
- **Polarity:** Specify the transponder's polarization.
- **TRANSMISSION:** Specify the modulation method used for the transponder. DVB-S2 is usually used for HD channels.

Make sure that the common options are properly configured before selecting **Service Search** to start a channel scan.

Scanning for One Channel

To scan for only one specific channel, set **Search Mode** to **Advanced**. Each satellite TV channel has unique packet IDs used

to distinguish between channels. In addition to the information about a target transponder, users need to know what packet IDs a target channel uses.

- **Video PID:** Specify the channel's video packet ID.
- **Audio PID:** Specify the channel's audio packet ID.
- **PCR PID:** Specify the channel's PCR (programme clock reference) packet ID. This is usually identical to video PID. If the video PID setting doesn't work, try 8191.







Make sure that the common options are properly configured before selecting **Service Search** to start a channel scan.

4 WATCHING TV

Use the channel buttons or the numeric buttons to change channels. When changing channels, a dialogue box appears showing information about the current programme on the current channel, such as programme title and running time. Pressing the **INFO**

button also displays the programme information dialogue box.

The following symbols may appear on the dialogue box to indicate what the current channel and programme features.

-  : This is a pay channel.
See Watching Pay Channels.
-  : Teletext pages are available.
See Viewing Teletext.
-  : Subtitles are available.
See Displaying Subtitles.
-  : Dolby audio is available.
See Audio and Video Settings.
- HD** : This is an HD channel.
See Audio and Video Settings.
-  : Subchannels are available.
See Watching Subchannels.
-  : The receiver is currently connected to the network.

Use the up and down navigation buttons to view information about the previous and following programmes, and use the left and right navigation buttons to view information about programmes on other channels. To view more information about the current programme, press the **INFO** button again. When a channel number other

than the current channel is displayed, pressing the **OK** button switches to the channel. Pressing the **FAV** button displays the list of channel groups, including favourites groups. After a group is chosen, users can change only between the channels that belong to the group.

4.1 Channel List

Use the channel list to change channels more easily. Press the **OK** button to open the channel list.

Switch to a specific channel: Place the focus on a channel entry using the navigation or numeric buttons, and then press the **OK** button.

Skip through a channel list: Use the up and down navigation buttons or, alternatively, the **Page up** and **Page down** buttons.

Display specific channels: Press the red button to sort or filter the channel list. A list of channel categories is displayed in the middle of the screen. Repeatedly pressing the red button displays different channel categories.

Choose a channel category and then a subcategory.

Add a channel to favourites groups: Place the focus on a channel entry and press the green button. A list appears showing multiple favourites groups. Select one or more groups, and then press the **EXIT** button to finish.

View a favourites group's channels: Press the **FAV** button and choose a favourites group.

Search for channels: Press the yellow button and enter search criteria using the on-screen keyboard.

Channel List Preferences

Press the blue button and set these options properly.

- **Service preview:** With this enabled, selecting a channel entry displays the channel's picture in the inset window on the upper right of the screen. Select it once more to switch to the channel. With this option disabled, selecting a channel entry immediately switches to the channel.

- **Keep viewing service when exit:** With this disabled, pressing the **EXIT** button switches to the channel that was focused on. With this option enabled, pressing the **EXIT** button closes the channel list without changing channels.
- **View only filtered list:** With this enabled, choosing a channel category filters out channels that are not in the chosen category.
- **Logical channel number:** Some channels have their own channel numbers, and others don't. With this option enabled, the receiver uses the proper numbers. Channels that don't have proper numbers are numbered from 1000. With this option disabled, channels are numbered in the order in which they are found.



- **HD service grouping:** With this option enabled, HD channels are grouped at the top of the channel list.

4.2 TV Programme Guide

The TV programme guide (EPG) provides schedule information for current and upcoming TV programmes.

Before using the programme guide, make sure that the clock is set correctly under **Settings > Time Setting**.

Press the **EPG** button to open the programme guide. Use the navigation buttons to browse the channel timeline.

Skip backward or forward by a day: Press the red button or the green button.

Change the timeline view: Pressing the **EPG** button alternates the timeline view between channel-based view and time-based view.

Change the time unit: Press the **FAV** button and set **EPG Time** scale shorter or longer.

View a programme's information: Press the **INFO** button on a programme entry.

Schedule a programme to watch: Select a programme entry and choose Play.

Schedule a programme to record: Select a programme entry and choose either **Once Record** or **Series Record**. For details, see **Scheduling TV Recordings Using the Programme Guide**.

Cancel a scheduled event: Select a programme entry that is scheduled to watch or record.

Search for programmes: Press the yellow button. Choose **Search** event name and enter search criteria. It is also possible to search by programme genre. Choose **Content** code and choose a genre.

Programme Guide Preferences

While most TV stations provide programme information for only a couple of days in each transponder, some TV stations, such as **Canal+** and **Sky**, use a dedicated transponder to provide programme information for 7 or more days. Press the blue button and determine which type of programme guide to use.

It takes a rather longer time for the receiver to get programme information

from the **MediaHighway** programme guide due to the large amount of information. Users can set the receiver to access the **MediaHighway** programme guide when the receiver turns on, to save time. Press the FAV button and set **Start MHW-Epg Automatic to On**.

Note

The MediaHighway programme guide may be not available, depending on the country.

A long-term programme guide needs more memory space, which may reduce the receiver's performance. Use a flash drive to save memory space. Press the FAV button, choose **Save EPG Data to Device**, and then determine which USB port's flash drive to use for saving of programme guide information.

4.3 Controlling Audio

When watching a channel, press the yellow button to control audio using these options:

- **Audio Track:** A TV programme may provide audio in two or more languages.

Choose a different audio language if available.

- **Sound Mode:** Generally, an audio track has two sound channels. Determine which sound channel to use.
- **Sound Level:** The volume may vary depending on channel. Use this to make the volume even at every channel. With this set to **High**, for example, the volume is automatically adjusted to the level that is higher 30% than the current channel's.

4.4 Displaying Subtitles

When the subtitle symbol  is highlighted on the programme information dialogue box, it indicates that subtitles are available in one or more languages for the current programme. Press **Subtitle** button and choose a subtitle language to display subtitles.

4.5 Watching Two Channels Simultaneously

Users can simultaneously watch two different channels contained in the same transponder, with one channel

shown in an inset window. It is also possible to watch a channel while playing a recording.

Note

Be aware that it is not possible to simultaneously watch channels that are not contained in the same transponder.

Press **PiP** button, and a window appears at a corner of the screen, displaying another channel. Pressing **PIP** button again displays the two pictures side by side at the same size. To close the window, press **PIP** button again.

Change channels for the foreground picture: Press the **PiP S. List** button and select a channel from the channel list that appears.

Swap the background picture with the foreground picture: Press **PiP Swap** button.

Change the location of the foreground picture: Press the **Page up** or **Page down** button.

4.6 Viewing Teletext

The teletext symbol  highlighted on the programme information dialogue box indicates that teletext pages are

available with the current channel. Press the **Teletext** button to display the teletext page.

Each teletext page has a page number. Enter a page number to view a different teletext page.

4.7 Watching Pay Channels

Pay channels are encrypted to prevent non-subscribers from watching them. Make sure to buy the correct pay-TV card, and CA module if necessary, to watch pay channels that are available.

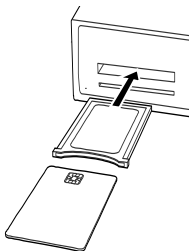

To watch **Conax-scrambled** pay channels, insert a **Conax pay-TV** card into the card slot. To watch non-Conax channels, insert a **pay-TV** card into a CA module, and then insert the **CA** module into the **CAM** slot.

To view the information about the pay-TV card, open the Apps screen and select **Manager > CAS**. Select the slot in which the pay-TV card or CA module is installed.

4.8 Watching Subchannels

Particular channels, such as sports channels or film channels, may have subchannels (multi-feed). For example, a film channel may use subchannels to air a single film with regular minutes-long intervals at the same time.

The subchannel symbol  highlighted on the programme information dialogue box indicates that the current channel has multiple subchannels. Press the blue button, and a list appears showing available independent programmes. Select a programme to watch it.

4.9 Setting Up Timers Wake-Up Timer

This receiver can be set to turn on at a specific time and tune in to a specific channel.

Open the Apps screen and select **Settings > Time Setting**. Determine how frequently to run the wake-up timer by setting **Wake Up Mode** to anything other than Off. According to this setting, specify the date, days of the week, time, and channel.

Sleep Timer

This receiver can be set to turn off at a specific time.

Open the Apps screen and select **Settings > Time Setting**. Determine how frequently to run the sleep timer by setting **Sleep Mode** to anything other than Off. According to this setting, specify the date, days of the week, and time.

4.10 Managing Channels

Press the OK button to open the channel list, and press **Play List** button .

Sort channels: Repeatedly pressing the red button sorts channels by a different category.

Search for channels: Press the yellow button and enter search criteria using the on-screen keyboard.

Lock or unlock channel: Press the blue button and select **Lock/Unlock Services**. Select one or more channels. Whenever a channel is selected, it appears in the list of locked channels on the middle of the screen. Selecting a channel from the list of locked channels unlocks it.

Rearrange channels: Press the blue button and select **Move Services**. Select one or more channels. Place the focus on a channel entry to move the selected channels above it, and then press the green button.

Delete channels from the channel list: Press the blue button and select **Delete Services**. Select one or more channels. Press the green button and then confirm to delete them.

Hide channels from the channel list: Press the blue button and select **Skip Services**. Select one or more channels. Whenever a channel is selected, it appears in the

list of hidden channels on the middle of the screen. Selecting a channel from the list of hidden channels makes it visible.

Add a new channel: Press the blue button, select **Edit Services**, and then press the green button. Specify the channel details, including frequency and channel name. Select Yes when finished.

Modify a channel's attributes: Press the blue button and select **Edit Services**. Select a channel and modify its attributes, such as channel name, for example.

Add channel to a favourites group: Press the blue button, select **Set Favorites**, and then press the green button to display the list of favourites groups. Choose a favourites group, then select one or more channels. Whenever a channel is selected, it appears in the favourites group on the middle of the screen. To select a different favourites group, press the green button and select a favourites group.

Remove channels from a favourites group: Press the blue button, select **Set Favorites**,

and then press the green button to display the list of favourites groups. Choose a favourites group, then select one or more channels from the favourites group.

Add a favourites group: Press the blue button, select **Set Favorites**, and then press the green button to display the list of favourites groups. Press the yellow button and enter a group name using the on-screen keyboard.

Rename a favourites group: Press the blue button, select **Set Favorites**, and then press the green button to display the list of favourites groups. Place the focus on a favourites group and press the green button. Enter a new name using the on-screen keyboard.

Rearrange favourites groups: Press the blue button, select **Set Favorites**, and then press the green button to display the list of favourites groups. Place the focus on a favourites group, press the **FAV** button, and then move it to a new location.

Delete a favourites group: Press the blue button, select **Set Favorites**, and then press the green button to display the list of favourites groups. Place the focus on a favourites group, press the blue button, and then confirm to delete it.

4.11 HbbTV

HbbTV combines TV services delivered via broadcast with services delivered via broadband. HbbTV services include video on demand, interactive advertising, voting, games, social networking, programme-related services, and more.

When watching a channel, a rounding circle may appear in the upper-right corner of the screen to indicate that HbbTV services are available. Press the red button to access the channel's HbbTV services via the Internet.

Note

The receiver must be connected to the Internet to use HbbTV services. HbbTV services may not be available, depending on the TV station.

5 RECORDING TV

This digital TV receiver can record TV programmes onto a removable hard drive or flash drive. However, flash drives are not recommended for recording.

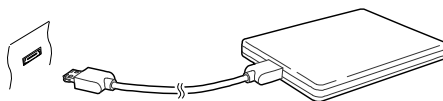

Connect a removable hard drive to one of the receiver's USB ports. For details on how to manage removable storage devices, see **Managing Storage Devices**.

5.1 Recording TV Programmes

Press **Record** button  to instantly begin recording the current programme.

Scheduling TV Recordings Using the Programme Guide

Use the programme guide to schedule TV recordings. Open the programme guide, and press the **OK** button on a programme entry scheduled to air later.

Either choose **Once Record** to record the programme only once, or choose **Series Record** to record its every episode.

At the scheduled time, the receiver turns on if it is off, and begins recording the programme. Even if the receiver is set to turn off before the time that the recording is supposed to finish, the receiver does not turn off until recording is done.

Manually Scheduling TV Recordings

Manual scheduling of programmes is sometimes needed because the programme guide is not always consistent with the actual broadcasting time. There may be changes in broadcast schedules or delays due to other programming.

Open the Apps screen and select **Schedule**.

Add a recording event: Press the green button. Specify the program details, including channel and start time. To display the programme at the

scheduled time without recording, set **Type to Play**. With **Alarm Confirm Message** enabled, a message appears to notify that the event will start in 3 minutes. Select **Yes** when finished.

View recording events by date: Press yellow button to open the calendar. Select a date to view its recording events.

Edit a recording event: Place the focus on an event entry, press the **OK** button.

Delete a recording event: Place the focus on an event entry, press the red button, and then confirm to delete it. To clear all events at once, press the blue button.

5.2 Time-Shifting

Time-shifting temporarily records the current programme. Using this feature, users can pause and resume a live programme and even scan through it backward or forward. For example, simply pause or skip backward in the current live programme to replay missed crucial scenes when answering a phone call, when having gone to the bathroom, or when wondering what a character in a drama just mumbled.

Before using this feature, make sure that **TimeShift Start** is set to **Auto** or **Manual** under **Settings > Recording Option**. For details, see **Recording Preferences**.

Pause the live programme: Press **Pause II** button. Press it again to resume.

Skip backward or forward: Press the play ► button to display the progress bar. Press the left or right navigation button. Repeatedly pressing the yellow button changes the skip interval from 10 seconds to 10 minutes.

Jump to the beginning of the time-shift recording: Press the previous button ◀.

Return to the live programme: Press the stop button ■.

5.3 Playing Recordings

Press the playlist button ▲ to access the recordings stored on removable storage devices. For details, see **Playing Recordings and Videos**.

Note

TV recordings cannot be played by any receiver other than the receiver that made them.

5.4 Recording Preferences

Open the Apps screen and select **Settings > Recording Option**.

- **Extra Recording Time Before Start:** It may be good to begin recording a few minutes earlier than the scheduled start time to avoid missing the beginning of a programme. Specify how much earlier the receiver should begin recording.
- **Extra Recording Time After Finish:** It may be good to finish recording a few minutes later than the scheduled end time to avoid missing the end of a programme. Specify how much later the receiver should finish recording.
- **TimeShift Start:** With this set to **Auto**, the receiver begins time-shift recording whenever changing channels. With this set to **Manual**, pressing the pause button II begins time-shift recording. With this set to **Off**, timeshifting is disabled.
- **TimeShift Duration:** Specify the maximum duration for time-shift recording. For example, if this is set to 30 minutes, only the last 30 minutes of the programme are temporarily preserved for playback.

- **Record Device:** Determine which storage device to use for recording by default.

6 PLAYING MEDIA FILES

This digital TV receiver can play not only TV recordings but also many kinds of media files, including photos, music, and videos. Connect a removable hard drive or flash drive to one of the receiver's USB ports.

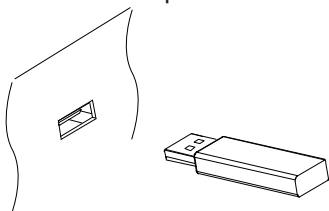

6.1 Managing Storage Devices

To manage removable storage devices connected to the receiver, open the Apps screen and select **Manager > Storage Manager**.

View a storage device's state: Choose **Current Device** and select a storage device.

Format a storage device: Storage devices must be formatted in FAT32 or NTFS for use with this receiver. Choose **Current Device** and select a storage device. Choose **Format**, choose **File System**, and then choose a file system.

Select **Format** and then confirm to format it.

Test the speed of a storage device: Choose **Current Device**, select a storage device, and then press the green button.

Open the file list of a storage device for playback: Choose **Current Device**, select a storage device, and then select **Play List**.

Remove a removable storage device from the receiver: Choose **Current Device** and select a removable storage device. Press the red button and then confirm to remove it.

Check a storage device: Choose **Current Device**, select a storage device, and then choose **Storage Check**. If any faults are found, they are automatically repaired.

Access a shared folder on a computer: Choose **Current Device** and select **Network Drive**. Choose **Network Setting**, choose **Folder**, and then specify the path to the folder.

A good example of shared folder paths is "192.168.1.25/media".

View the state of the user-available memory: Choose **Current Device** and select **User**.

6.2 Managing Files

Press the playlist button ▲ to access the removable storage devices connected to the receiver.

Display only files of a specific type: The chosen file type is displayed on the top left of the screen. Press the left or right navigation buttons to see files of a different type. To display all files, regardless of file type, choose **Play List**. **Imported Files** stands for videos except TV recordings.

View files on another storage devices: Press the playlist button ▲ and choose a different storage device.

Sort files: Press the yellow button and choose a category.

Create a folder: Press the blue button and select **New Folder**.

Rename a file or folder: Place the focus on a file or folder, press the blue button, and

then select **Rename**. Enter a new name using the on-screen keyboard.

Move files or folders into another folder:

Select one or more files or folders using the red button, and press the blue button. Select **Move to Folder** and choose a subfolder or the upper folder.

Copy files or folders onto another storage

device: Select one or more files or folders using the red button, and press the blue button. Select **Copy to Device** and choose a different storage device.

Delete files or folders: Select one or more files or folders using the red button, and press the blue button. Select **Delete** and confirm to delete them.

6.3 Playing Recordings and Videos

Select one or more recordings or videos using the red button, and then press the **OK** button to play them.

Note

Some videos may not play properly, depending on how they are encoded.

Pressing the play button ► displays the progress bar. Use the progress bar to navigate through the video. To hide the progress bar, press the play button ► again.

Pause and resume playback: Press the pause button II, and press it again to resume.

Skip backward or forward: Press the left or right navigation button. To continuously skip, press and hold these buttons. Repeatedly pressing the yellow button changes the skip interval from 10 seconds to 10 minutes.

Skip to a specific point: Press the play ► button to display the progress bar, and then enter a number. This action can be configured to perform differently. See **Recording Preferences**.

Play fast forward or backward: Press the forward button or the backward button. Repeatedly pressing these buttons changes the playback speed.

Skip to the previous or next recording or video: Press the previous button or the next button.

Add a bookmark to a recording: When playing a recording, users can add bookmarks to the recording for easier navigation. Press the red button to place a vertical marking bar at the current point on the progress bar. Bookmarks are preserved with the recording for later use.

Note

Only TV recordings can be bookmarked.

Jump to a bookmark: Press the green button.

Remove a bookmark: Jump to a bookmark using the green button, and then press the red button to remove the bookmark.

Change subtitle display: When a video is playing, press the **MENU** button and change subtitle display options, such as letter size and color. For details on how to add font files, see *Using Different Fonts*.

Note

SMI and SRT subtitle formats are only supported by the receiver.

6.4 Viewing Photos

View the previous or next photo: Press the left or right navigation button.

Start slideshow: Press the red button. To pause and resume the slideshow, use the Pause button.

Slideshow Preferences

On the list screen, press the **RECALL** button.

- **Slide Time:** Adjust the slideshow speed.
- **Repetition:** Determine whether or not to repeat slideshows.
- **Title:** Determine whether or not to display file names.
- **Downscale:** Determine whether or not to display a reduced size.

Set **Installation** to Yes to finish.

6.5 Playing Music

Select one or more songs using the red button, and then press the **OK** button to play them.

Skip to the previous or next song: Press the previous button ◀ or the next button ▶.

Shuffle or repeat playback: Press the red button. Repeatedly pressing the red button changes the play mode.

[R] : Songs are randomly played.

A : Songs are played only once.

[A] : All songs are repeated.

[1] : The current song is only repeated.

Add songs to the current playlist: Press the green button. Select more songs using the red or green button, and then press the yellow button.

Remove a song from the current playlist: Place the focus on a song entry and press the yellow button.

6.6 Playing Media files from Other Devices

This receiver can play media files from computers or other DLNA-enabled devices, such as TVs and tablets, connected to the receiver via a network.

For example, when a computer and the receiver is connected to the same

network, the receiver accesses the computer to play the computer's media files, or vice versa.

Accessing Other Devices

Open the apps screen and select **Media > Remote Play+**. The file list screen appears with the list of detected devices. Select a device and then select a file to play it.

For details on how to play videos, see *Playing Recordings and Videos*, for music, see *Playing Music*, and for viewing photos, see *Viewing Photos*.

Allowing Other Devices to Access the Receiver

Open the apps screen, select **Manager > Media Server**, and then select Start.

When **Start Type** is set to **Auto**, other devices can access the receiver at any time when the receiver is on.

7 APPS

Press the **MENU** button to open the Apps screen. Most Apps require an internet connection for proper operation.

7.1 Web Browser

Use **Web Browser** app to surf the Internet.

Note

Web Browser cannot play flash video, which is heavily used on the web.

Pressing the **MENU** button displays a toolbar, including a web address field and several icons, at the bottom of the screen.

Viewing a Webpage

Web Browser takes up the lower part of the screen so that users can watch live TV on the upper part.

Adjust the vertical view size: Press the red button or, alternatively, press the **MENU** button and select the vertical view icon . Repeatedly pressing the red button changes the view size from full screen to half and then to quarter.

Adjust the horizontal view size: Press the green button or, alternatively, press the **MENU** button and select the horizontal view icon .

Zooming in a webpage: Press the yellow button.

Zooming out a webpage : Press the blue button.

Navigating Webpages



A pointer is available to help users navigate webpages. Use the navigation buttons to move the pointer. To see another webpage, move the pointer over a link and press the **OK** button.

Enter a web address: Press the **MENU** button, select the web address field, and then enter a web address using the on-screen keyboard.

Refresh a webpage: Press the **MENU** button and select the refresh icon .

Halt a webpage from downloading: Press the **MENU** button and select the stop icon .

Move between the series of webpages that have already been viewed:

Press the **MENU** button and select the back icon  or the forward icon .

View the web browsing history: Press **RECALL** button to display the list of recently-visited webpage. Select a webpage to open it.

Bookmarks

Bookmark the current webpage: Press the **FAV** button and press the red button. A bookmark shortcut to the webpage is created in the **Web Browser** app folder.

Open a bookmarked webpage: Press **FAV** button to display the list of bookmarked webpages. Alternatively, press **MENU** button and select the bookmark icon . Select a bookmark to open it.

Delete a bookmark: Press the **FAV** button and place the focus on a bookmark. Press the yellow button and confirm to delete it.

Edit a bookmark: Press the **FAV** button and place the focus on a bookmark. Press the blue button and edit the web address using the on-screen keyboard.

Set the current webpage as home page: Press the **FAV** button and press the green button.

Open the home page: Press the **MENU** button and select the home page icon .

Entering Text

Switch to a different language keyboard:

Press the **MENU** button and select the keyboard icon . A list appears, showing available keyboard layouts. Choose a keyboard layout, and then choose a keyboard language. Restart **Webzeal** to put the chosen keyboard into use.

Switch between the numeric keypad and the normal keyboard: Press the **MENU** and press the green button.

Enter text into a field: When the pointer is over a text field, pressing the **OK** button displays available typing actions. Choose **Input Text** and enter text using the on-screen keyboard.

7.2 YouTube

Use the YouTube app to watch videos from the YouTube website.

View videos in a specific category: Press the green button and choose a category.

Search for videos: Press the yellow button and enter search criteria using the on-screen keyboard.

Download a video: Place the focus on a video entry and press record button .

View the list of downloaded videos: Press the red button.

Playing Videos

Select a video from the list of videos to play it.

Note

Some videos may not play properly, depending on how they are encoded.

View in full screen: Press the **OK** button. To exit full screen, press it again.

Pause and resume playback: Press the pause button , and press the play button  to resume.

Skip backward or forward: Press the backward button  or the forward button .

7.3 Free TV+

Free TV+ allows users to view videos from a variety of video-sharing web services, such as **Dailymotion**. Users can either view videos online or download them for later enjoyment.

7.4 Internet TV+

Use Internet TV+ to watch internet TVs.

Tune in to a TV station: Select a TV station.

View in full screen: Press the blue button. To exit full screen, press it again.

Add a TV station: Press the red button.

Specify the TV station's details, including name and web address, and then select **Add** to finish.

Note

The web address must include "http://" and indicate the media itself, not the webpage that contains it.

Edit a TV station: Place the focus on a TV station entry and press the green button. Change the details, and select **OK** to finish.

Delete a TV station: Place the focus on a TV station entry, press the yellow button, and then select Yes.

Clear all TV stations: Place the focus on a TV station entry, press the yellow button, and then select **All**.

7.5 Internet Radio+

Use Internet Radio+ to listen to internet radios.

Tune in to a radio station: Select a radio station.

Add a radio station: Press the red button. Specify the TV radio's details, including name and web address. Select Add when finished.

Note

The web address must include "http://" and indicate the media itself, not the webpage that contains it.

Edit a radio station: Place the focus on a radio station entry and press the green button. Change the details, and select OK to finish.

Delete a radio station: Place the focus on a radio station entry, press the yellow button, and then confirm to delete it.

Clear all radio stations in a category: Press the blue button.

Add a category: Press the **INFO** button, enter a category name, and then select Add to finish.

Delete a user-added category: Place the focus on a user-added category, press the **RECALL** button, and then confirm to delete the category and all the radio stations in it.

7.6 RSS News

Use **RSS News** app to view frequently updated information from websites, such as blog entries and news headlines.

Add a new RSS subscription: Press the red button. Specify the **RSS** source's details and web address, and then select **Add** to finish.

View feeds from an RSS subscription: Select an **RSS** subscription. To view more of a longer **RSS** feed, press the right

navigation button and use the up and down navigation buttons to scroll through it. To select another **RSS** subscription, press the **MENU** button.

Edit an RSS subscription: Place the focus on an **RSS** subscription entry and press the green button. Change the details, and select **OK** to finish.

Delete an RSS subscription: Place the focus on an **RSS** subscription entry and press the yellow button.

Clear all RSS subscriptions: Press the blue button.

7.7 User Data

Some internet-based apps, including Internet TV+, requires users to enter web addresses. Typing a long web address using the remote control would annoy users. As a solution to this problem, the **User Data** provides add-ons available for those apps.

Choose a target app: Choose an app from among applicable ones that are displayed when this app starts. To

choose a different app after choosing one, use the left or right navigation buttons.

Download and install web addresses: Select one or more add-on entries using the **OK** button, and press the red button to start downloading.

7.8 TV Portal+

TV Portal+ is a web portal, run by this receiver's manufacturer, that brings together web content dedicated for consumer electronics from diverse websites.

There are multiple web categories, including news and multimedia.

Use the navigation buttons to navigate the web categories and the **OK** button to select an item. Press the **Recall** or **Exit** button to return to the previous screen.

Note

Web categories and items in each category may change.

7.9 Torrent Player

Many people use **µTorrent**, a peer-to-peer file sharing program, to share media files. **Torrent Player** can communicate with **µTorrent** on a computer to play media files downloaded by **µTorrent**.

Before using **Torrent Player**, make sure that **µTorrent** is installed on a computer on the same network as the receiver.

Start **Torrent Player**, and a list appears showing computers on which **µTorrent** is running and computers that have been connected to **Torrent Player**. Select a computer to connect it to **Torrent Player**. If this is the first connection, enter the number displayed on the receiver's screen into **µTorrent's** dialogue box.

Selecting a media category displays a list of files of the same type that are currently managed by **µTorrent**. Select a media category, and then select a file to play it.

The **Torrent** category displays the torrents list. Selecting a torrent shows

all the files contained in it. Select a file to play it.

Note

It is not possible to play files that are not completely downloaded.

7.10 Weather Forecast

Use the **Weather Forecast** app to get weather forecasts for thousands of places around the world.

Add a city: Press the red button to display a list showing countries. Select a country and then select one of its cities.

Alternatively, press the green button and enter search criteria using the onscreen keyboard. Select a city from search results.

View another city's weather: Use the left and right navigation buttons or, alternatively, press the yellow button and select one from the list of user-chosen cities that appears.

Set a city as start point: Place the focus on a city entry and press the blue button.

7.11 Plugin

You can download and install various Apps provided by Xcruiser.

Download new apps: Open Apps screen and select **Download > Plugin**. A list appears showing new available apps. Select one or more Apps using **OK** button, and press the red button to start downloading.

Play an app: Open the Apps screen and select **Plugin**. Place the focus on an app and press the green button.

Delete an app: Open the Apps screen and select **Plugin**. Place the focus on an app and press the yellow button.

Plugin Server Settings

The **Plugin** server's web address may need to be reconfigured properly. For information about the **Plugin** server, contact the local distributor.

Open app screen and select **Download > Setting**. Place the focus on **Plugin Server**, press the red button, and then enter a new web address.

8 PREFERENCE SETTINGS

8.1 Language Settings

Open the Apps screen and select **Settings > Language Setting**.

- **Menu Language:** Determine what language to use for the interface.
- **Audio Language:** A TV programme may provide audio in two or more languages. Determine what audio language to use by default.
- **Audio Language2:** Determine what audio language to use as an alternative when the default language is not available.
- **Subtitle Language:** A TV programme may provide subtitles in one or more languages. Determine what subtitle language to use by default.
- **Subtitle Language2:** Determine what subtitle language to use as alternative when the default language is not available.
- **Teletext Language:** A TV channel may provide teletext pages in one or more languages. Determine what teletext language to use by default.

8.2 Network Settings

A wired network connection is required to perform internet tasks.

- Using media apps, such as **Weather** and **Free TV+**
- Accessing a computer to play media files stored on it
- Acquiring software updates

Open the Apps screen and select **Settings > Network Setting**.

It may be more convenient to set the router for dynamic IP addresses so that the receiver can automatically connect to the network. Turn on DHCP if DHCP is enabled on the router.

If DHCP is not available, specify the network details, including IP address and gateway.

Proxy Server Settings

If a proxy server is used for internet connections, the settings for the proxy server must be configured properly. Open the Apps screen, select **Settings**

> **Network Setting**, and then choose **Proxy Server**. Specify the proxy server's details, including port number and user account.

DDNS Settings

A DDNS account allows the receiver to create a web address that points to the user's local network, so anyone can access the receiver from anywhere in the world.

If a DDNS account is available, configure the DDNS settings properly. Open the Apps screen, select **Settings > Network Setting**, and then press the red button. Specify the DDNS account's details, including web address and user account.

8.3 Clock Settings

Open the Apps screen and select **Settings > Time Setting**.

- **Time Setting:** With this set to Auto, the receiver uses date and time information delivered via broadcast.
- **Local Offset:** Specify the time zone where

the receiver is located.

- **Daylight Saving:** To apply daylight saving time, specify the country where the receiver is located.
- **Clock Mode:** Determine which to use between 12-hour and 24-hour clock formats.

For **Wake Up Mode and Sleep Mode**, see **Setting Up Timers**.

8.4 Audio and Video Settings

Open the Apps screen and select **Settings > A/V Output Setting**.

- **TV Type:** Determine which TV standard to use.
- **TV Aspect Ratio:** Determine which aspect ratio to use by default.
- **Display Resolution:** Determine which resolution to use by default. Technically, 1080p is better than 1080i, but the difference is only slight to most people.
- **Display Format:** Determine how to display 4:3 pictures on the 16:9 screen, or vice versa.

- **Pillar Box:** 4:3 pictures fit the height of the 16:9 screen with black bars on the sides.
- **Full:** 4:3 pictures blow up to fit the width of the 16:9 screen with the top and bottom edges cut off.
- **Letter Box:** 16:9 pictures fit the width of the 4:3 screen with black bars on the top and bottom.
- **Pan Scan:** 16:9 pictures blow up to fit the height of the 4:3 screen with the sides cut off.
- **HDMI Dolby Digital:** Determine whether or not to pass through **Dolby** audio via HDMI when available.
- **Dolby Digital Default:** Determine whether or not to use **Dolby** audio when available.
- **Sound Mode:** Generally, an audio track has two sound channels. Determine which sound channel to use by default.
- **Audio Sync Delay:** If the sound and picture don't match up, adjust this until they match.

8.5 On-Screen Display Settings

Open the Apps screen and select Settings > Display Setting.

- **Info Box Display Time:** Specify how long to display the programme information dialogue box when changing channels.

Using Different Fonts

Users can install truetype font files in the receiver to use them with subtitles and displays.

On the computer, open **Windows Explorer** to access the receiver. Enter the receiver's IP address into the Address Bar. Once it's connected, move to the "root/var/font" directory. If the "font" directory is not found, create it under the "var" directory. Copy font files into the "font" directory.

Open the Apps screen and select **Settings > Display Setting**. Choose **User Font File** and choose a font to use it for text display. Additional options for the chosen font appear, as follows:

- **User Font Language:** Choose a language to use the font for it.
- **User Font Size Correction:** Adjust the font size.

To clear all user-installed fonts, press the red button.

8.6 Parental Control

TV programmes are rated according to their level of violence, nudity, and restricted language. It is possible to set the receiver to block programmes rated a certain class or higher to prevent children from watching them. It is also possible to lock specific Apps so that children or others can't access them. Users must enter the passcode to watch a blocked programme or access a locked app.

Open the Apps screen, select **Settings > Parental Control**, and then enter the passcode.

- **Censorship:** Specify a programme rating.
- **Change PIN code:** Change the passcode. The default is "0000".

- **System:** With this set to **Lock**, the passcode is required when turning on the receiver.
- **Settings:** With this set to **Lock**, the passcode is required when accessing the **Settings** app.
- **PlugIn:** With this set to **Lock**, the passcode is required when accessing the **PlugIn** app.
- **Play List:** With this set to **Lock**, the passcode is required when pressing the playlist button to access a removable storage device.

8.7 Maintaining the Digital TV Receiver

The internal flash memory is used for maintaining the preference settings and channel data.

Open the Apps screen and select **Settings > System Recovery**.

Use these to reset or back up and restore the digital TV receiver.

- **System restore to factory default:** Reset all settings to factory defaults and clear all

channels.

- **System restore to stored position:** Restore the receiver using the stored settings and channels.
- **Store system data:** Back up all settings and channels.
- **Delete stored position:** Clear all stored settings and channels.

Sharing Channel Data

It is possible to share the receiver's settings and channel data with other receivers of the same kind, using a flash drive. Connect a flash drive to one of the receiver's USB ports.

Open the Apps screen and select **Manager > Data Transfer**.

- **Transfer All System data to USB storage:** Export all settings and channel data to the flash drive.
- **Transfer Service data to USB storage:** Export all channel data to the flash drive.
- **Data download from USB storage:** Import settings and channel data from the flash drive.

8.8 Updating the Digital TV Receiver

Software updates for this digital TV receiver become available from time to time. Software updates may improve the receiver's performance or deal with any outstanding issues.

Open the Apps screen and select **Manager > System** to check the current version of the receiver. For the website to download the latest update file from, contact the local distributor.

Make sure that the available version is newer than the currently installed version before downloading it.

Decompress the update file and copy it into the root directory of a flash drive.

Connect the flash drive to one of the receiver's USB ports. A dialogue box appears showing available update files. If the receiver fails to recognize the flash drive, open the Apps screen and select **Download > USB Storage**. Select an update file and press the red button. Never turn off the receiver until the update process is complete.

Online Update

Online software updates may be available, depending on the country.

Open the Apps screen and select **Download > Software**. A list appears showing available updates. Select one or more items, and press the red button to download and install them.

Software Server Settings

The software server's web address may need to be reconfigured properly.

For information about the software server, contact the local distributor.

Open the app screen and select **Download > Setting**. Place the focus on **Software Server**, press the red button, and then enter a new web address.

If necessary, change the user account as well, using the green and yellow buttons.

9 APPENDIX

Legal Notices



The terms HDMI and HDMI High-Definition Multimedia Interface, and the HDMI Logo are trademarks or registered trademarks of HDMI Licensing LLC in the United States and other countries.



Manufactured under license from Dolby Laboratories. Dolby and the double-D symbol are trademarks of Dolby Laboratories.

Correct disposal of this product



This marking shown on the product or its literature indicates that it should not be disposed with other household wastes at the end of its working life. To prevent possible harm to the environment or human health from uncontrolled waste disposal, please separate this from other types of wastes and recycle it responsibly to promote the sustainable reuse of material resources.

Household users should contact either the retailer where they purchased this product or their local government office for details of where and how they can dispose this product for environmentally safe recycling.

Business users should contact their supplier and check the terms and conditions of the purchase contract. This product should not be mixed with other commercial wastes for disposal.

XCRUISER



XDSR385HDplus

High Definition Digital Satellite Receiver

© 2014 Xcruiser corporation, Korea. Reproduction in whole or in part without written permission is prohibited. All rights reserved.